



Ss John Fisher and Thomas More
Roman Catholic High School

Curriculum Policy

Compiled by: JWo	Date: September 2023
Approved by: SEC	Revision Date: September 2024

CURRICULUM POLICY

This policy will be reviewed every year by the senior leadership team. At every review, the policy will be shared with the governing board.

Curriculum Intent

The overriding ambition of our curriculum is to cater for the needs of all our pupils and enhance their life chances.

This ambition links to our core vision of enabling every child to achieve more than they think they can achieve by letting all their bright colours shine – a vision which is at the heart of everything we do as a school.

Our vision reflects our belief in Jesus' call to fullness of life. Therefore, the overriding ambition of our curriculum is to give our pupils every opportunity to flourish, to develop their God given talents to the full and enhance their life chances so that they achieve all that they want to in life.

Our belief that humans are created in the image and likeness of God means that all people have an inherent and immeasurable worth and dignity. This gives us a radical equality before God which is the basis of our commitment to the principle that every member of the school community is entitled to equal opportunities and treatment, irrespective of ethnic or national origin, race, gender, physical disability, sexual orientation, marital status, social background, or religion.

Everything we do is underpinned by our Christian faith and our belief in equality of opportunity for all and our conviction that pupils' starting points in life and their social and economic status should not define their endpoints.

By the end of each pupil's time at Fisher More, we aim to have transformed their lives and educational prospects through a wide-ranging and ambitious curriculum that does not cease at the boundaries of the classroom or the school. We teach knowledge rigorously but also place an emphasis on skills and preparing pupils for the world of higher education and work.

As such:

- Our curriculum aims to meet the needs of all pupils, providing each individual pupil with a range of opportunities to learn and achieve. Pupils should build on their strengths and develop their enjoyment of and commitment to learning. In doing so, pupils develop their knowledge, skills, and abilities to the full and can maximise their true potential.
- The Catholic ethos of our school forms the basis of the curriculum. The curriculum promotes pupils' spiritual, moral, social, and cultural development. In particular, the curriculum enables pupils to grow in their Christian Catholic faith and to function as active, responsible Christians in an ever-changing world.

At Ss John Fisher Thomas More RC High School, our curriculum seeks ...

- To ensure that all pupils receive a broad, deep and knowledge rich curriculum
- To ensure that all pupils build their character and develop socially, morally, and mentally as Catholics while also understanding fundamental British values and appreciating the breadth of cultural diversity and values within Britain
- To ensure that all pupils are prepared for higher education and the world of work, so that every pupil will leave Fisher More with a clear plan and strategy for their progression
- To ensure that all pupils have high expectations for their own behaviour and achievement
- To ensure that all pupils are literate and numerate
- To ensure that all pupils experience a wide variety of learning opportunities outside of the classroom through an extensive programme of curriculum enhancement
- To ensure pupils can access the curriculum from home through a broad remote learning offer

All pupils receive a broad, deep, and knowledge-rich curriculum

We offer a wide range of subjects at Key Stage 3 and 4 to all pupils, including Music, Drama, Art, and Spanish, as we do not wish to restrict our pupils in any way or inhibit their creativity. Furthermore, to ensure they are not disadvantaged, we offer as many pupils as possible the opportunity to study and qualify for the English Baccalaureate.

We develop our teaching practice through collaborative work and value whole school staff training and INSET highly. For example, all departments have redesigned their curricula in the year to place a greater emphasis on consolidation of key skills and knowledge through quizzing, online learning and other appropriate pedagogical innovations rooted in educational theory.

All pupils build their character and develop socially, morally, and mentally while also understanding fundamental British values and appreciating the breadth of cultural diversity and values within Britain

Our Catholic ethos and focus on Gospel values underpins everything that we do in and out of school. Our pupils have opportunities to worship together, attend Mass, and regularly pray and reflect during personal development time in the afternoon. Our assembly and PSHE programmes help our pupils to navigate the challenges of the modern world such as materialism, consumerism and radical individualism and serves to deepen their faith. We aim to nurture pupils spiritually as well as academically, with their journey towards the world of higher education and work moving hand in hand with their development as positive role models and good Christians. We take seriously the teaching of other faiths to prepare the pupils in our school for life in modern Britain. This in turn will improve social cohesion and contribute to the common good by increasing mutual respect between those of different religions and those of no faith.

The local community is important to us and our connections within the local area – including with our local churches and Priests - further demonstrate the extent to which Fisher More is a Christian community. Our community work is testament to the fact that we not only want to prepare our pupils for the highest standards of further education they can access, but that our pupils also leave Fisher More as responsible and caring citizens who embody both British values and the Gospel values.

To ensure that all pupils have high expectations for their own behaviour and achievement

Our robust pastoral system is simultaneously a reflection of our Catholic ethos and a structure that supports our pupils to achieve and progress through the curriculum. We focus on our pupils as individuals as well as full year group cohorts. Strategically planned assemblies, personal development time and workshops ensure that we teach pupils how to keep themselves safe in an ever-changing digital world, as well as the challenging environment in which our pupils live, and our school is situated. We teach pupils the Gospel values of compassion, justice, and mercy. We are inclusive and ambitious for all. We have high expectations of all pupils and provide opportunity for pupils to learn what is expected of them morally. Our rigorous and systematic behaviour policy ensures that pupils learn that actions have consequences, and they can accept and appreciate differences between people. We always have a focus on good manners and encourage pupils to act as ambassadors for the school.

All pupils are literate and numerate

The development of literacy and oracy is at the forefront of our curriculum as we understand how vital it is for our pupils to build confidence in communication skills not only for their time in school but also to prepare them for working life. We ensure pupils have opportunities in all

subjects to discuss, challenge and build on other points of view and to develop their formality of language to ensure they can have the confidence to speak to different audiences. Extended writing is considered a crucial skill within all subject areas and has a key role within our subject curricula. Pupils who arrive from primary school with below expected literacy and numeracy skills are quickly caught up through expert teaching and incisive intervention. Whole school reading and use of our Learning Resource Centre is encouraged as much as possible.

All pupils experience a wide variety of learning opportunities outside of the classroom through an extensive programme of curriculum enhancement

Our curriculum also ensures that our pupils can experience environments they have never experienced before. Our curriculum ensures that pupils participate in debating and learn to speak confidently in a variety of different situations, as well as participate in the democratic process through our house councils.

Our wide range of clubs and societies enhances our curriculum, allowing our pupils to flourish.

Curriculum Implementation

Fisher More believes that a meticulously planned and structured curriculum is the solid foundation required for effective learning. Our curriculum is designed and implemented in such a way that it ensures pupils can build on their prior knowledge and are always prepared for the next stage in their education. This approach is complemented by the school's rigorous and developmental teaching and learning programme and our commitment to meaningful whole school training and INSET.

As far as pupils are taught in ability groups to aid teachers with differentiation. We seek to ensure that lessons are engaging and suitably differentiated, but also that all pupils are challenged and stretched and receive access to the same curriculum.

Subject Leaders, who are experts in their respective fields, are given the confidence and tools required to carefully construct a curriculum that promotes a deep understanding of a wide range of topics. Teachers plan learning that allows pupils to embed and recall knowledge through techniques such as quizzing, flipped learning and frequent assessment. This builds firm foundations for progression to the next level and exam success.

Curriculum Impact

At Fisher More, our curriculum...

- ensures that sequences of learning build on previous knowledge whilst supporting future progression.
- leads to qualifications that are of worth for employers and for entry to further education and training.
- enables all pupils to fulfil their potential.
- meets the needs of pupils of all abilities
- allows pupils to acquire an appreciation and respect for their own and other cultures
- prepares pupils to make informed choices at the end of KS3, KS4 and beyond.

Organisation of the Curriculum

Contents

- A. Broad curriculum objectives**
- B. Organisation in Year 7, Year 8 and Year 9**
- C. Organisation in Year 10 and Year 11**
- D. Curriculum structure**
- E. Options for both KS4 year groups**

Broad curriculum objectives

All pupils follow a similar curriculum in Years 7, 8 and 9 which aims to provide a broad and balanced education in creative, practical and academic subjects.

In Years 10 and 11, all pupils continue their studies in a core curriculum of RE, English, Mathematics, Science and PE. Other subjects are chosen so as to recognise the value of a balanced curriculum whilst allowing for career aspirations and personal interests.

Boys and girls have equal access to opportunities in each subject and curriculum area.

The same standards of personal effort, courtesy, behaviour, concern for one's neighbour and respect for property can be expected of all pupils in order to create a sense of order and self-discipline which is characterised by fairness and justice.

The teaching of each subject is planned to match language, content, method, and process to the pupils' learning.

Pupils who experience learning difficulties are identified and supported through the coordinated efforts of the Curriculum Support department, their subject teachers and, where appropriate, teaching assistants.

A structured programme of curriculum support, which is flexible to meet the changing needs of our pupils, is provided through:

- a) Reduced number of Spanish teaching periods
- b) Extra-curricular accelerated learning sessions to boost reading, spelling, communication, numeracy and language skills.
- c) A personalised curriculum at KS4 for a small group of pupils
- d) Integration into regular ability groups in other subjects – support is provided through the Curriculum Support department and TAs to prepare suitable teaching materials and provide in class support
- e) Support from a TA who works in direct support of each pupil according to their EHCP.

Each subject is able to recognise its potential to contribute to the development of:

- Literacy skills of reading, listening, speaking and writing
- Numeracy through the application of mathematical concepts and skills to practical examples and situations.
- Citizenship and economic awareness.
- ICT skills
- Group skills and team work
- Independent study skills
- Self-respect, self-confidence, and personal responsibility
- The skills, knowledge and inter personal skills necessary to take one's place as adults in a modern, ever changing world.
- A more mature understanding of the concepts of right and wrong.

Pupils are taught to understand human relationships and the associated moral teaching through an organised programme in several areas of the curriculum. Sex and Relationship Education (SRE) are integrated into this programme so as to meet the needs of the pupils as they grow and develop towards maturity. It is the role of the RE department to bring these

elements together in the context of Catholic teaching on the love of God and our neighbour and the sanctity of marriage.

Achievement, progress and personal service are recognised and rewarded through the house awards system

In years 7, 8 and 9 ICT knowledge and skills are developed through the taught ICT course.

Sporting, cultural and artistic activities are encouraged and supported so as to give pupils the opportunity to develop personal interests and enter more fully into the life of the school. An annual and planned programme of school visits is organised for their educational and social contribution to the curriculum.

Organisation of Year 7, Year 8 and Year 9

Year 7: Each pupil is a member of a mixed ability tutor group and is placed in the care of a form tutor who is expected to show an interest in their welfare and progress. The tutor group retains a stable identify throughout the five years of secondary schooling and is used for the purposes of registration, pastoral care, inter-house competitions, routine administration and aspects of personal development.

Tutor groups are named after the Cathedral cities of England, Ireland, Scotland and Wales.

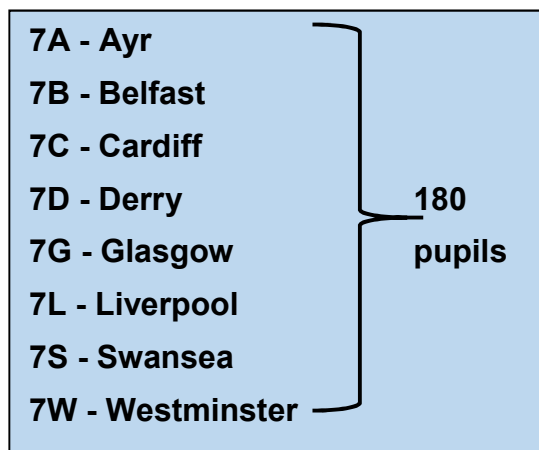

In year 7, pupils are taught in seven ability groups for Maths, English, Science, RE, History, Geography, Spanish, Computer Science and Drama. Pupils are grouped according to ability based on prior performance at KS2, internal assignments and CAT scores. Each pupil's progress is reviewed termly so that their grouping reflects attainments personal effort and likely potential.

The different needs of Food Technology, Graphics, Art and Music are recognised by creating four smaller mixed ability groups in each half of the year group. PE is also taught to half a year group at a time.

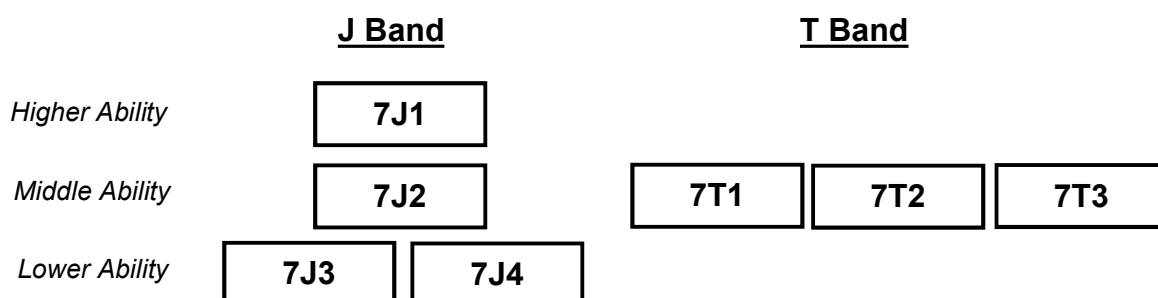

The different needs of Food Technology, Graphics, Art and Music are recognised by creating four smaller mixed ability groups in each half of the year group. PE is also taught to half a year group at a time.

*Some pupils may study Spanish for 2 periods over the two-week timetable and have additional support with personal development during the other two periods led by the Technology and Vocation department.

Year 8: Pupils remain in the same mixed ability tutor group as in Year 7.

Tutor groups are named after the Cathedral cities of England, Ireland, Scotland and Wales.

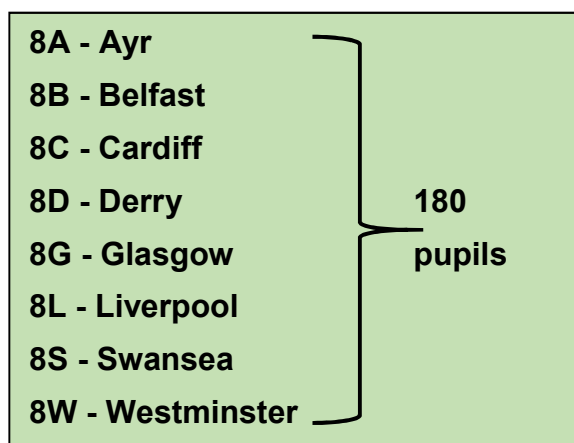

In Year 8, pupils are taught in seven ability groups for Maths, English, Science, RE, History, Geography, Spanish, Computer Science and Drama. Pupils are grouped according to ability based on prior performance at KS2, internal assignments and CAT scores. Each pupil's progress is reviewed termly so that their grouping reflects attainments personal effort and likely potential.

The different needs of Food Technology, Graphics, Art and Music are recognised by creating four smaller mixed ability groups in each half of the year group. PE is also taught to half a year group at a time.

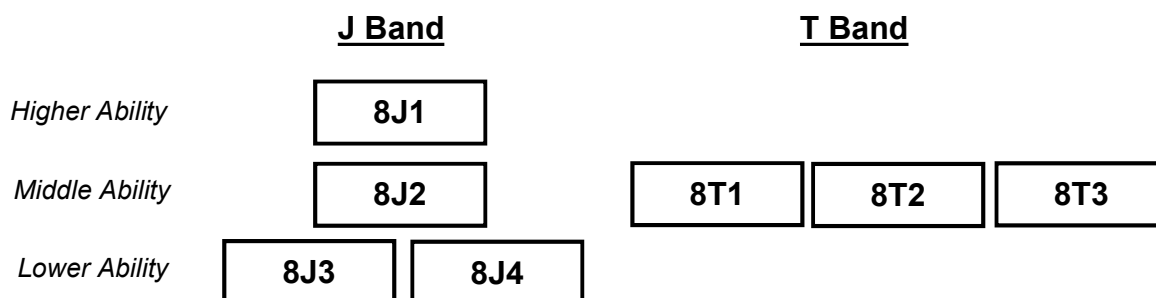

The different needs of Food Technology, Graphics, Art and Music are recognised by creating four smaller mixed ability groups in each half of the year group. PE is also taught to half a year group at a time.

*Some pupils may study Spanish for 2 periods over the two-week timetable and have additional support with personal development during the other two periods led by the Technology and Vocation department.

Year 9: Pupils remain in the same mixed ability tutor group as in Year 8.

Tutor groups are named after the Cathedral cities of England, Ireland, Scotland and Wales.

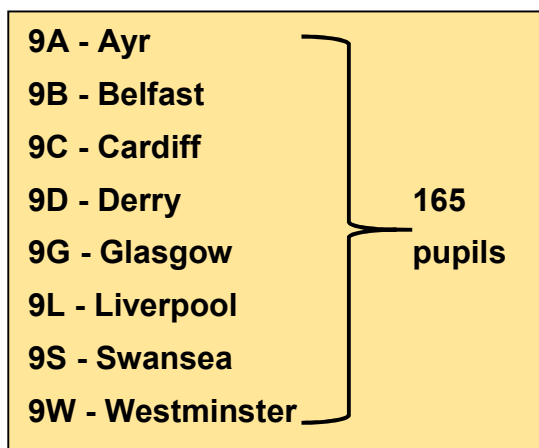

Year 9 pupils are taught in six ability groups for English, RE, History, Geography, Spanish and Drama. In Year 9 Maths, Science and Computer Science, pupils are independently set from other subjects across the year group. Pupils are grouped according to ability based on prior performance at KS2, internal assignments and CAT scores. Each pupil's progress is reviewed termly so that their grouping reflects attainments personal effort and likely potential.

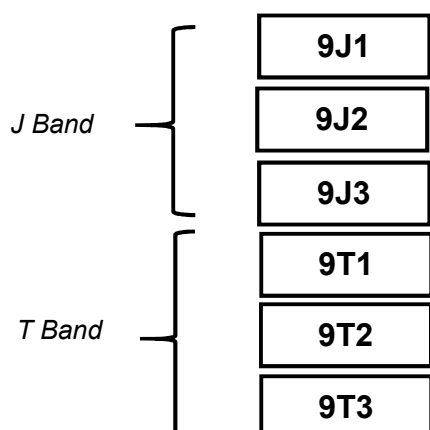

The different needs of Food Technology, Graphics, Art and Music are recognised by creating four smaller mixed ability groups in each half of the year group. PE is also taught to half a year group at a time.

*Some pupils may study Spanish for 2 periods over the two-week timetable and have additional support with personal development during the other two periods led by the Technology and Vocation department.

Organisation of Year 10 and Year 11

Year 10: Pupils remain in the same mixed ability tutor group as in Year 9.

Tutor groups are named after the Cathedral cities of England, Ireland, Scotland and Wales.

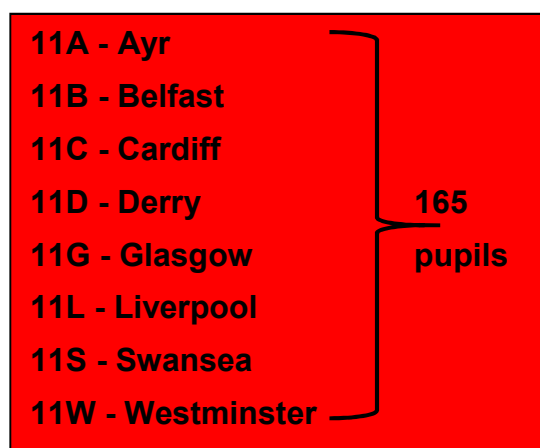
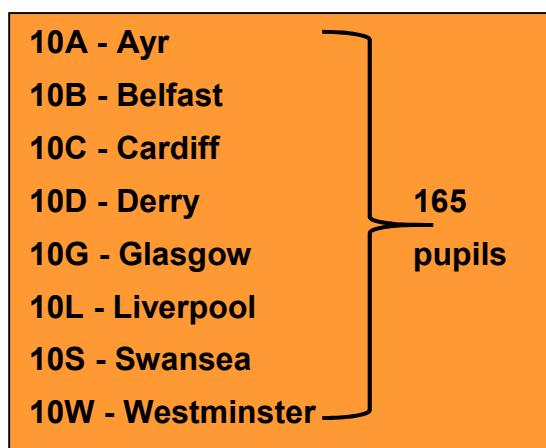

Key Stage 4 pupils are taught in six ability groups for the core curriculum English, Maths, RE and Science (double or triple). Pupils are independently set for English and RE (J and T Band) and for Maths and Science (P and Q band). Pupils are grouped according to ability based on prior performance at KS2, internal assignments and CAT scores. Each pupil's progress is reviewed termly so that their grouping reflects attainments personal effort and likely potential. Core PE is taught to half a year group at a time.

All pupils have access to the full range of choices, and will make 3 option choices with most pupils going on to gain 9 or 10 GCSEs. Pupils must select one subject from History, Geography, Spanish and Computer Science to study and a further two options from a range of GCSEs and vocational subjects. Option blocks are formed based upon the pupil choices, staffing availability and sufficient numbers to run a particular course. Guidance is given to ensure that courses are appropriate and the curriculum is broad and balanced. Prior to choosing their options all Year 9 pupils undertake a guidance programme which includes information in the form of an options subject booklet and videos, taster sessions, subject presentations, Parents' Evenings and an individual 1-2-1 interview with a senior member of staff before making their final choice.

Some pupils who require additional support with their studies will be advised to study the ASDAN – Personal and Social Effectiveness qualification. This course provides challenge for pupils and include aspects of personal organisation, social skills, building self-esteem, preparation for the workplace, along with additional support to help develop literacy and numeracy skills.

There is also provision, where appropriate, for pupils to study for a variety of entry level qualifications.

Curriculum Structure 2023-2024

The curriculum is designed to provide a 'knowledge rich' experience so pupils are engaged in order to know and remember more right across the curriculum.

The curriculum is adapted from the National Curriculum and the Diocesan Directory for RE in order to meet the needs of all pupils with opportunities for cultural enrichment.

All pupils will follow a 50-period timetable over a two-week period. Lessons will be 1 hour in duration.

Key Stage 3		Key Stage 4	
Subject	Number of Lessons a fortnight	Subject	Number of Lessons a fortnight
English	7	English	9 in Year 10 8 in Year 11
Maths	7	Maths	8 in Year 10 9 in Year 11
Science	6	Science	10
RE	5	RE	6
Spanish*	4	Core PE	2
Geography	4	Option 1	5
History	4	Option 2	5
Technology/Art/Music	5 in Year 7 & 8 4 in Year 9	Option 3	5
Computer Science	3	Option Subjects include: History, Geography, Spanish, Computer Science, Triple Science, GCSE PE, Food & Nutrition, Graphics, Media Studies, Creative iMedia, ASDAN and BTECs in Sport, Art, Music and Health & Social Care	
Drama	1 in Year 7 & 8 2 in Year 9		
PE	4		

In addition to the formal taught timetable, pupils have the opportunity to take part in specific learning activities organised throughout the school year which take the place of normal lessons. This will involve field trips, theatre groups, guidance and wellbeing sessions and “Enrichment Week” (in July) which includes blocked sessions which develop knowledge and skills in based on a particular theme.

Options for Year 10 and Year 11

Options for the current Year 10

Block A	Block B	Block C
Geography History iMedia Media Studies PE Study Skills Spanish Food	Art Computer Science Digital IT Geography History Health & Social Care PE Food	Asdan Drama Geography History Music PE Spanish Graphics Triple Science

Options for current Year 11

Block A	Block B	Block C
Computer Science Food Geography Health & Social Care Music BTEC Sport Graphics Triple Science	Computer Science Food Geography History iMedia BTEC Sport Spanish	ASDAN Art Computer Science Drama Geography History 1 History 2 Health & Social Care Graphics

PSHCE

Our PSHCE programme will be delivered to all pupils from year 7-11. Pupils will be in mixed ability classes and have one 50-minute lesson per week covering a range of topics from the three areas of the PSHCE statutory curriculum: health and wellbeing, relationships and livings in the wider world.

Assessment

- All pupils are assessed in all subjects formally twice a year from year 7. Targets are set for minimum progress based on KS2 SATs.
- Subjects may supplement these assessments with further summative assessments during the school year in line with the subject curriculum and if they see fit.
- Departments formally review assessment data and pupil progress after each set of exams and departments in conjunction with the pastoral team intervene to challenge any under-achievement.
- Parents will receive one written report a year. The report will indicate the progress that pupils have made towards their target grade and an indication of their behaviour and attitude to learning. Parents Evenings will also provide parents with a verbal report provided by the subject teacher.

Curriculum Review

- Curriculum implementation and impact is reviewed, and quality assured through line management, light touch learning walks and formal lesson observation programmes.
- The curriculum delivered in each subject is reviewed annually by subject leaders to ensure the sequence of delivery allows pupils to build on their knowledge and that pupils are sufficiently stretched and challenged.
- The curriculum hours and subjects offered are analysed by the senior leadership team on an annual basis.
- During the Covid-19 pandemic the curriculum was reviewed constantly in every subject area to consider changes to external exams in 2022. Investment has also been made in equipment, training and INSET to ensure the highest possible standard of remote learning.